

FREE- POINT

FreePoint Monopoint Lighting

Edison Price Lighting
Los Angeles, CA



All rights reserved. © Edison Price Lighting 2025
Due to continuous product improvements, specifications and dimensions are subject to change without notice.
Consult www.epl.com for most current technical information.



The Art of Adaptive Lighting.

Engineered for flexibility and longevity, FreePoint allows for the seamless integration and reconfiguration of optical modules. Its design is grounded in functionality, featuring a standardized mounting interface that simplifies installation and ensures ease of modification or replacement, all while keeping costs in check. The modules are meticulously designed to blend into ceilings, offering a discreet yet impactful presence.

FreePoint is an investigation into the efficiency of design, providing a versatile framework that caters to evolving aesthetic and functional needs without compromising on style.



LIGHTING MODULES



SINGLE APERTURE SERIES

SPOTLIGHTS

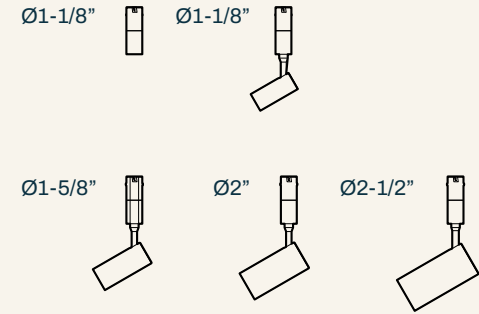

DECORATIVE

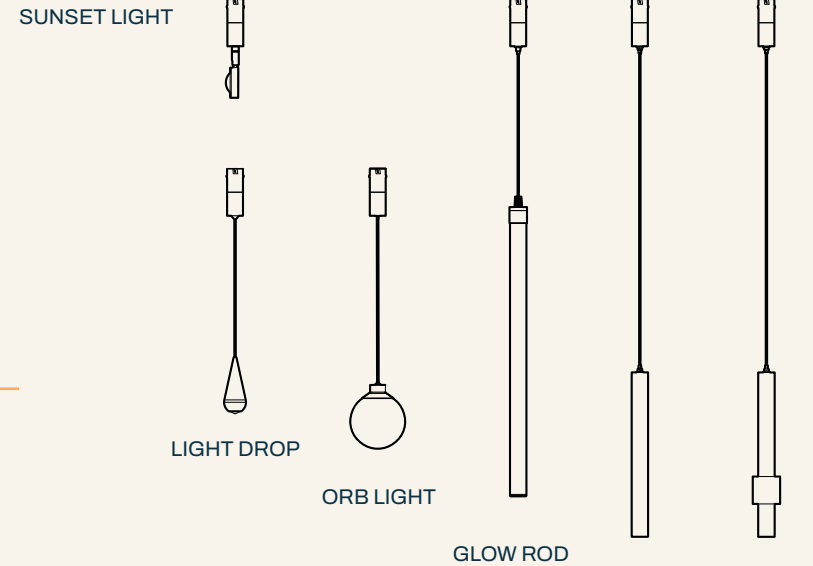

ADJUSTABLE BEAM (12°-50°)

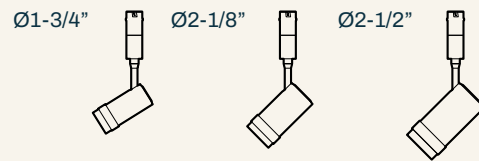

LINEAR

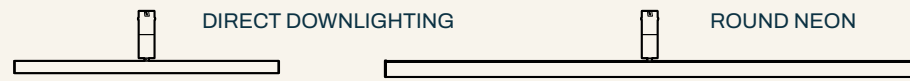

DOUBLE APERTURE SERIES

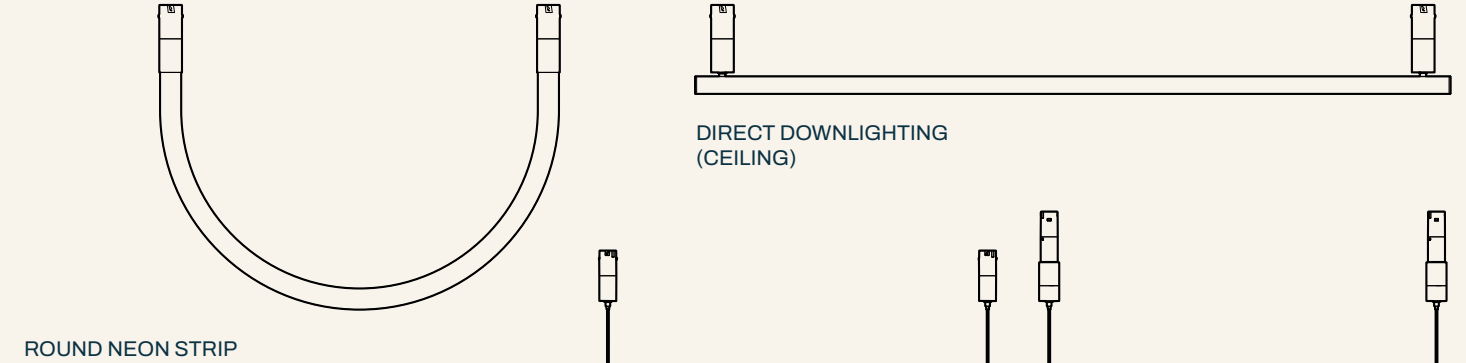

DIRECT DOWNLIGHTING (CEILING)

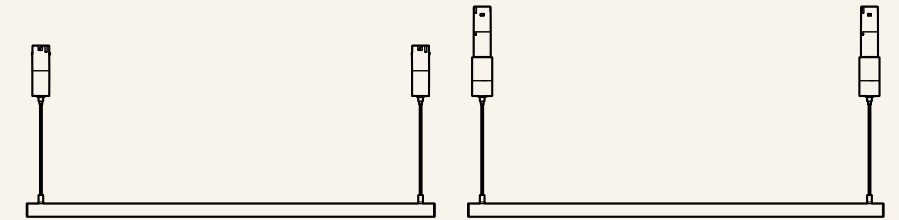

DIRECT/INDIRECT LIGHTING (PENDANT)

DIRECT/INDIRECT LIGHTING (HEIGHT-ADJ.)

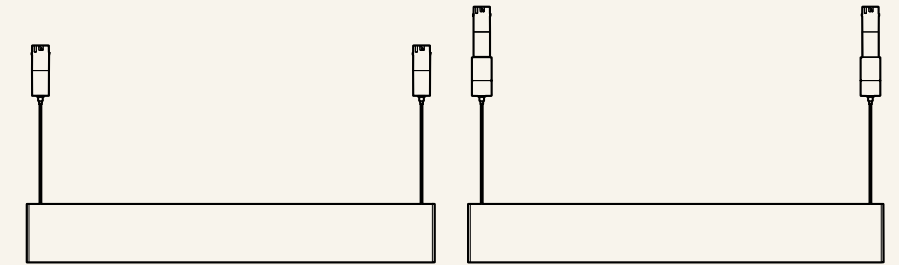

OPTICS

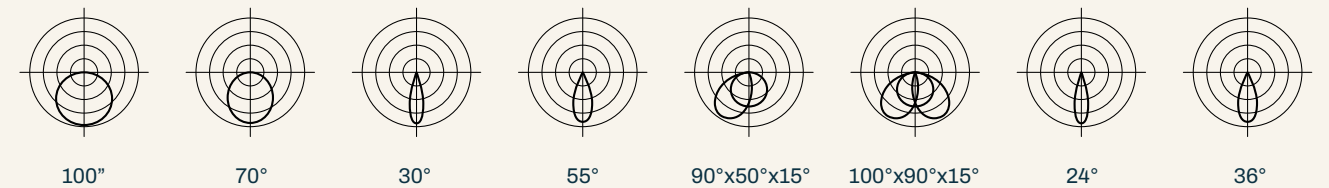



23 modules.

All rights reserved. © Edison Price Lighting 2025
Due to continuous product improvements, specifications and dimensions are subject to change without notice.
Consult www.epl.com for most current technical information.

MODULES
Spotlights
Linear
Neon

Ø1,1/8"–Ø2,1/2"
24,1/8"–94,5/8"
39,3/8"–196,1/8"

DIMMING+
CONTROLS
0-10V
DALI-2
TUYA
CASAMBI

CCT
27K
30K
35K
40K
CRI
90+



All rights reserved. © Edison Price Lighting 2025
Due to continuous product improvements, specifications and dimensions are subject to change without notice.
Consult www.epl.com for most current technical information.

RECESSED.

FLANGE-LESS



flush-mount

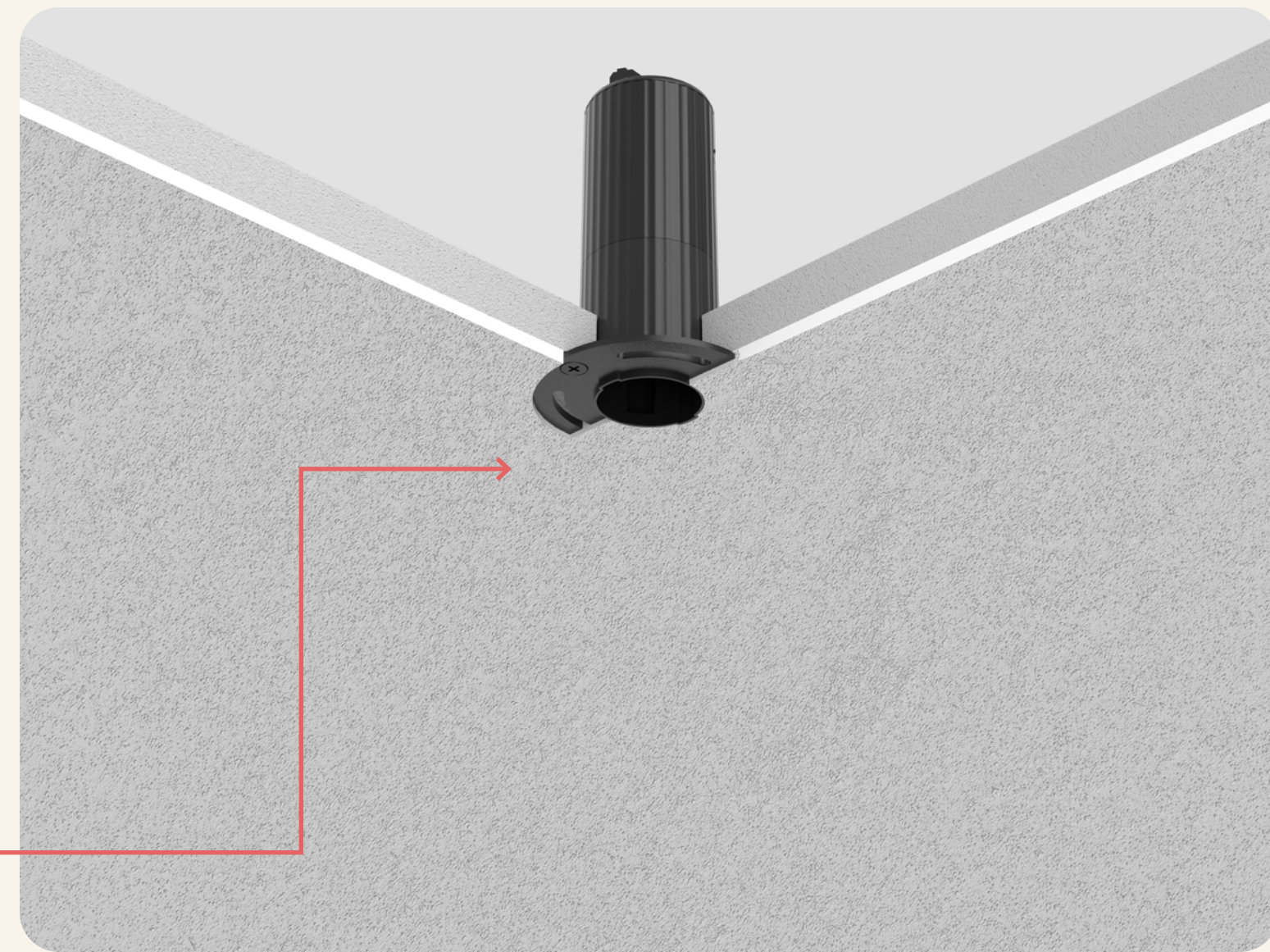

RECESSED.

FLANGED TRIM



recessed
cover

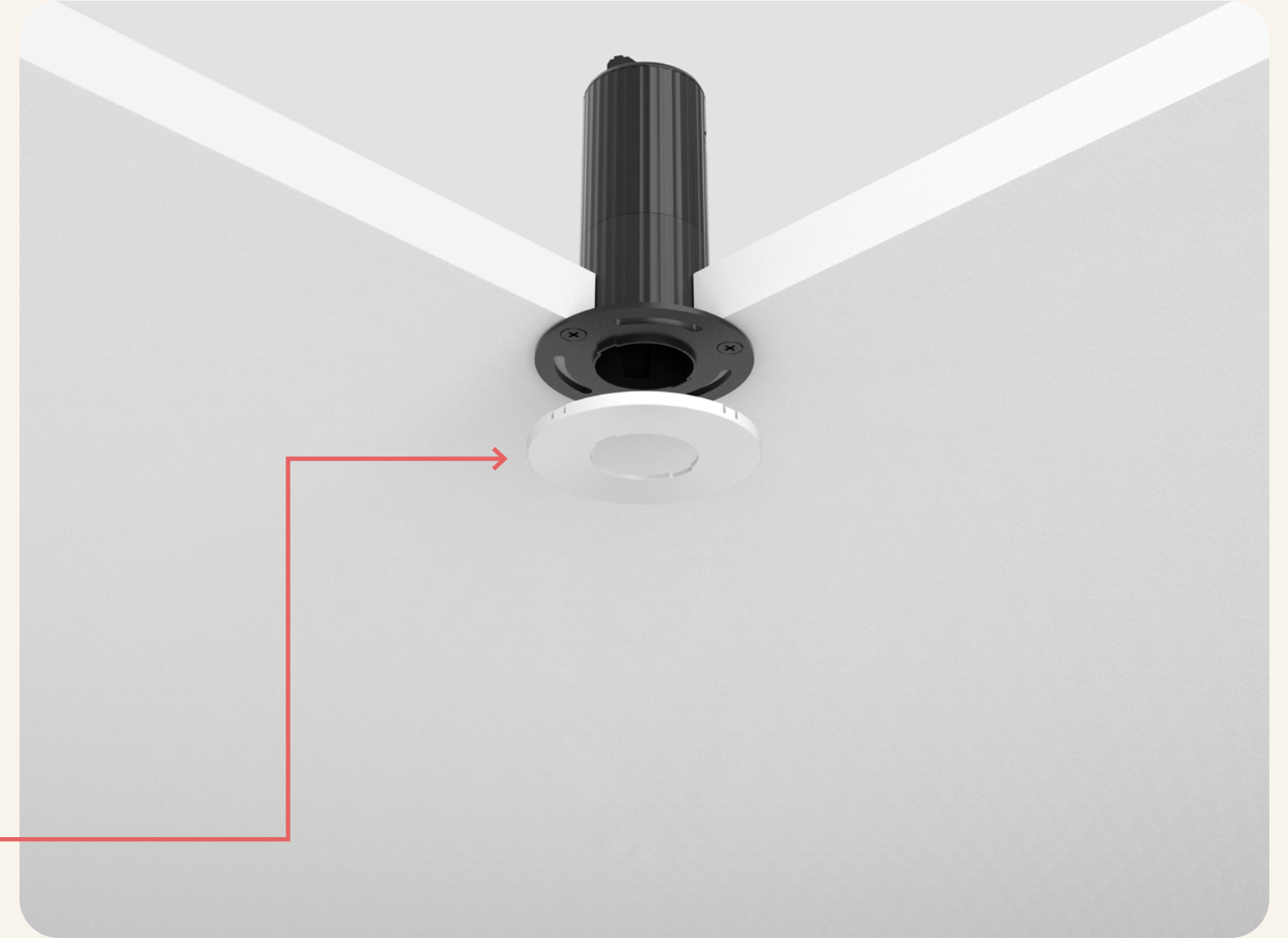

THE BUILD.

base

Maximum Loaded
Weight 18 lbs.

light module

FreePoint's unified interface seamlessly integrates diverse modules into a cohesive system.

This scalability allows for an expanding module collection while maintaining consistent elements.



The Mechanical Process.

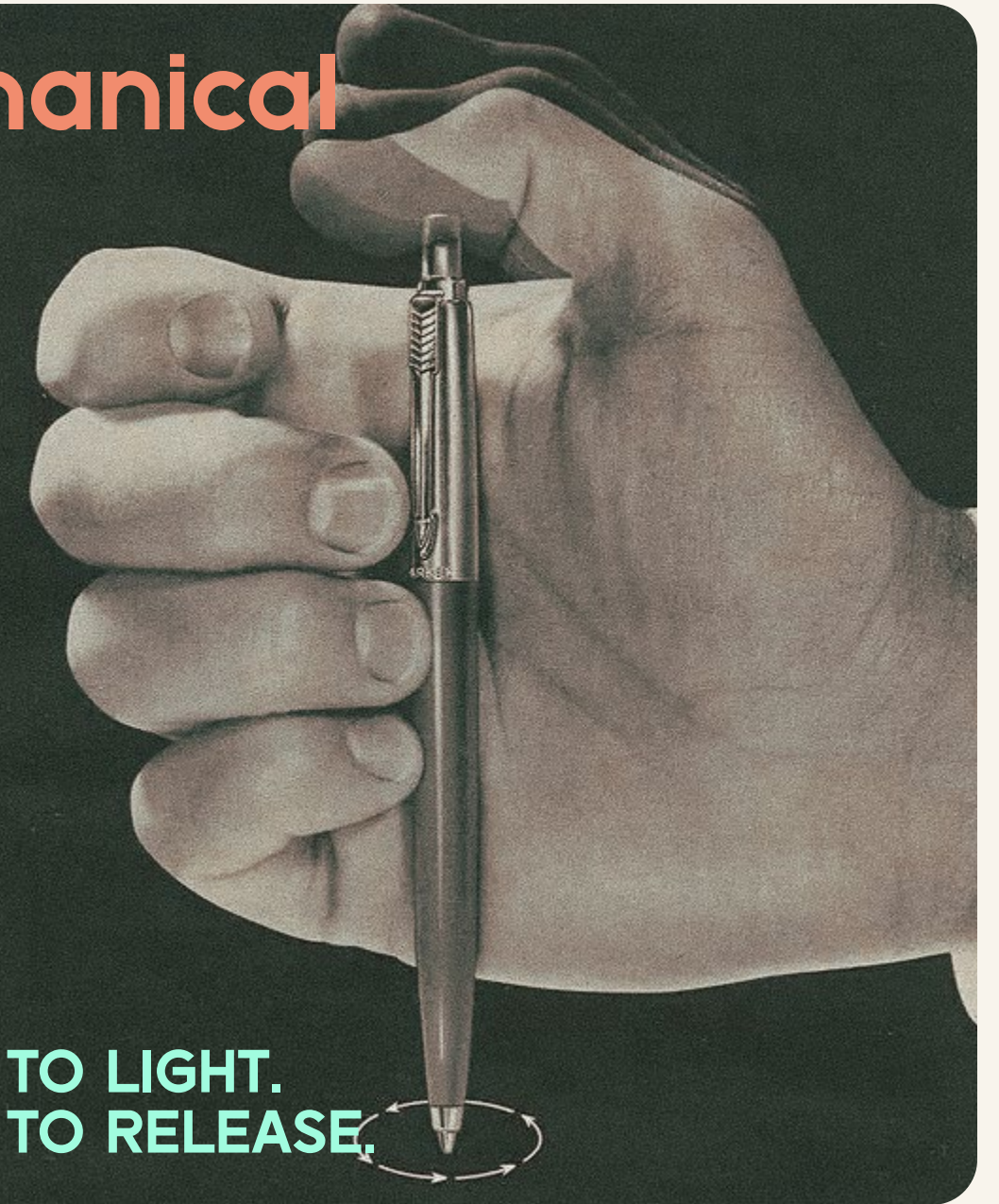

**PUSH TO LIGHT.
PUSH TO RELEASE.**

© 1963. THE PARKER PEN COMPANY, JANESVILLE, WISCONSIN, USA.

SPOTLIGHTS.

ADJUSTABLE
BEAM!



FRM-102

Lumens: 250 lm
Beam Angle: 12°-50°
Size: Ø 1-3/4" x 4"

Black (BK)



FRM-202

Lumens: 500 lm
Beam Angle: 15°-40°
Size: Ø 2-1/8" x 4-1/2"

Black (BK)



FRM-302

Lumens: 700 lm
Beam Angle: 15°-36°
Size: Ø 2-1/2" x 5-3/8"

Black (BK)



Spotlights.



FRM-101

Lumens: 300 lm
Beam Angle: 24°, 36°
Size: Ø 1-1/8" x 2-1/8"
Black (BK)



FRM-201

Lumens: 500 lm
Beam Angle: 24°, 36°
Size: Ø 1-5/8" x 3-3/8"
Black (BK)



FRM-301

Lumens: 1020 lm
Beam Angle: 24°, 36°
Size: Ø 2" x 4-3/4"
Black (BK)



FRM-401

Lumens: 1080 lm
Beam Angle: 15°, 24°, 36°
Size: Ø 2-1/2" x 5-3/8"
Black (BK)

Quiet luxury. Subtle indulgence.

Experience a space where innovation
illuminates life's finer moments.

Our lighting isn't just about seeing better;
it's about feeling more deeply, elevating every
corner with a gentle, human touch.
Here, light is not just a feature;
it's the heartbeat of hushed elegance.



Linear Single-Hole

FRM-103

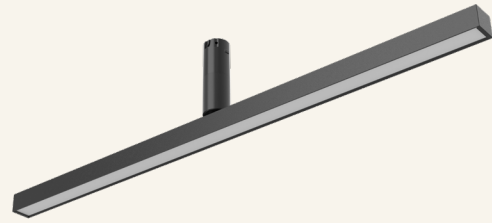

Sizes(s) & Lumens:
24 inches, 900 lumens
35 inches, 1350 lumens
47 inches, 1800 lumens

Beam Angle: 110°

Finish: Black (BK)

Lens: Frosted Diffuser

FRM-203



Sizes(s) & Lumens:
24 inches, 960 lumens
35 inches, 1140 lumens
47 inches, 1920 lumens

Beam Angle: 70°

Finish: Black (BK)

Lens: Microprismatic

fully rotatable $\pm 355^\circ$

FRM-503



Sizes(s) & Lumens:
26 inches, 910 lumens
51 inches, 1820 lumens

Beam Angle: 30°, 55°

Finish: Black (BK)

Lens: Microcell (Grating)

FRM-303



Sizes(s) & Lumens:
24 inches, 1200 lumens
35 inches, 1800 lumens
47 inches, 2400 lumens

Beam Angle: 90° x 45° x 15°

Finish: Black (BK)

Lens: Wallwash (Asymmetric)

Frosted Diffuser, Microprismatic, MicroCell,
Wall Wash, Batwing, Wall Grazer



fully rotatable $\pm 355^\circ$

FRM-403



Sizes(s) &
Lumens:

24 inches, 1200 lumens
35 inches, 1800 lumens
47 inches, 2400 lumens

Beam Angle:

100° x 90° x 15°

Finish:

Black (BK)

Lens:

Batwing (Double Asymmetric)

FRM-603



Sizes(s) &
Lumens:

24 inches, 900 lumens
48 inches, 1800 lumens

Beam Angle:

60° x 25° x 73°

Finish:

Black (BK)

Lens:

Wall Grazer

LINEAR PENDANT

FRM-106

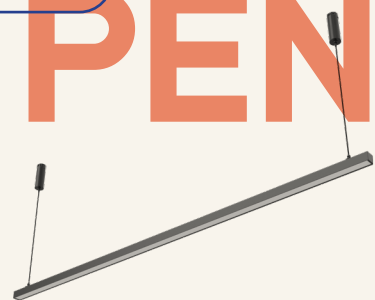

Sizes(s) & Lumens:

47 inches, 1800 lumens
59 inches, 2250 lumens
71 inches, 2700 lumens
95 inches, 3600 lumens

Beam Angle:

110°

Finish:

Black (BK)

Lens:

Frosted Diffuser

FRM-206

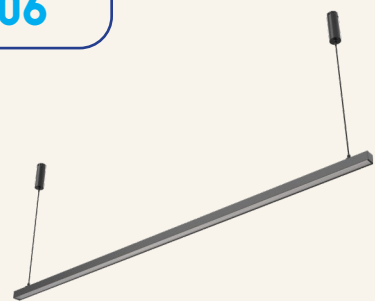

Sizes(s) & Lumens:

47 inches, 1920 lumens
59 inches, 2400 lumens
71 inches, 2880 lumens
95 inches, 3840 lumens

Beam Angle:

70°

Finish:

Black (BK)

Lens:

Microprismatic

FRM-606



Sizes(s) & Lumens:

51 inches, 1820 lumens
77 inches, 2730 lumens

Beam Angle:

30°, 55°

Finish:

Black (BK)

Lens:

Microcell (Grating)

Frosted Diffuser, Microprismatic, MicroCell



Direct/Indirect Frosted Diffuser, Microprismatic, MicroCell

DOUBLE-HOLE

FRM-107

Lens: Frosted Diffuser
Beam Angle: 110°
Size & Lumens: 48 inches, 2880 lumens
59 inches, 3600 lumens
71 inches, 4320 lumens
95 inches, 5760 lumens
Finish: Black

FRM-207

Lens: Microprismatic
Beam Angle: 70°
Size & Lumens: 48 inches, 2976 lumens
59 inches, 3720 lumens
71 inches, 4464 lumens
95 inches, 5952 lumens
Finish: Black

FRM-307

Lens: Microcell (Grating)
Beam Angle: 30°, 55°
Size & Lumens: 51 inches, 2862 lumens
77 inches, 4212 lumens

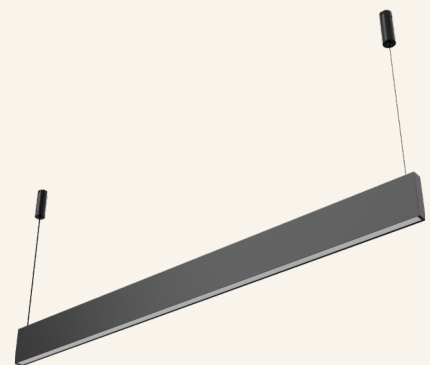
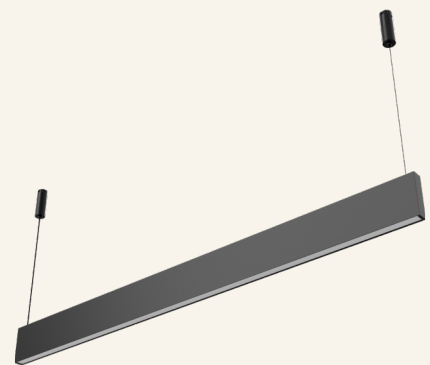
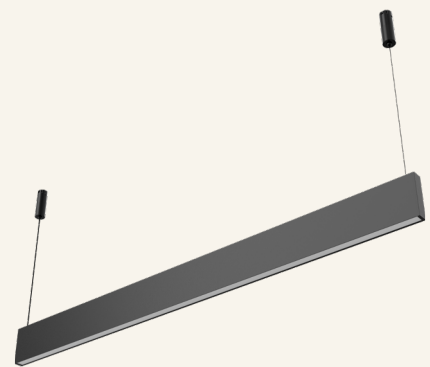

Suspended beauty.

Indulge in the soothing, golden embrace of a sunset, immerse yourself in the graceful ballet of descending water droplets, or surrender to the timeless allure of suspended spheres above.

Allow these enchanting elements to turn your surroundings into a mesmerizing symphony of light and wonder.

DECORATIVE

six options



FRM-405

Diameter: 4 inches
Lumens: 600 lumens
Beam Angle: 360°
Finish: Black

FRM-305

Diameter: 2 inches
Lumens: 390 lumens
Beam Angle: 24°, 36°
Finish: Black

FRM-105

Dimensions: 1-1/4 inches
20 inches long
Length: 490 lumens
Beam Angle: 360°
Finish: Black

FRM-605

Diameter: 4 inches
Lumens: 600 lumens
Beam Angle: 360°
Finish: Black

FRM-205

Diameter: 2 inches
Lumens: 390 lumens
Beam Angle: 24°, 36°
Finish: Black

FRM-505

Dimensions: 1-1/4 inches
20 inches long
Length: 490 lumens
Beam Angle: 360°
Finish: Black



DOWNLIGHT

Precision, style, and impact combined.

Experience remarkable color accuracy, glare-free comfort, and efficient 3-watt illumination that effortlessly adapts to your needs.

FRM-501

- Diameter: 1-1/8 inches
- Lumens: 135 lumens
- Beam Angle: 15°, 25°
- Finish: Black

NEON

FRM-304

ONE-INCH
ROUND NEON

Diameter:
1 inch

Lengths &
Lumens:

39 inches, 840 lumens

98 inches, 2100 lumens

197 inches, 4200 lumens

Finish:
Black



shape your atmosphere.



**curve your
ambiance.**

NEON

FRM-104

ONE-INCH RIGID NEON

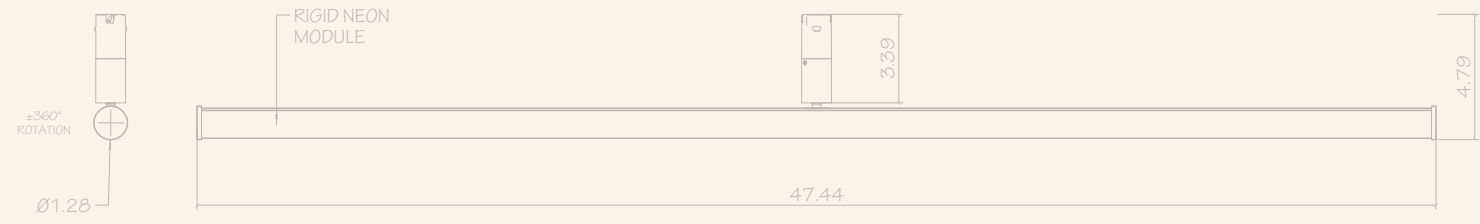

Diameter:

1 inch

Finish:

Black



Lengths & Lumens:

24 inches, 1200 lumens

36 inches, 1800 lumens

48 inches, 2400 lumens



designed to captivate
and endure

